

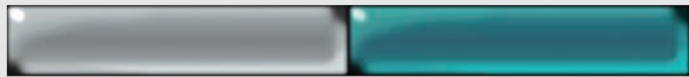

PROMESS



Sensing Systems for Manufacturing



Electro-Mechanical Assembly Press Systems

A fully electric assembly
press system with
integrated motion control
and monitoring.

**If you're not using our technology
now, you're pressing your luck.**

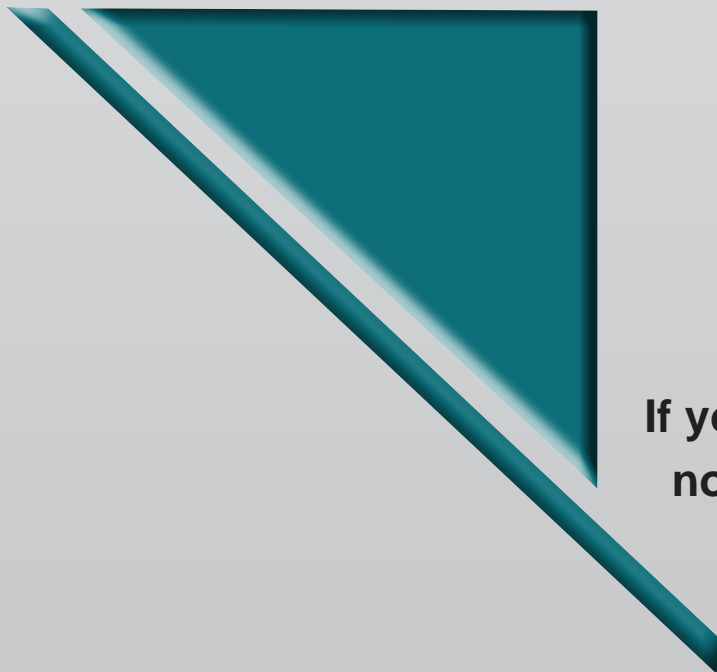

Electro-Mechanical Assembly Press

If you need to push, pull, position, monitor and control every aspect of your assembly process, Promess has the **solution** for you. The Electro-Mechanical Assembly Press (EMAP) System.

The Promess EMAP systems combine our servo-driven ball screw press technology with our single or multi-axis fully programmable controls and software to provide a high precision, closed-loop press system with integrated signature analysis and gauging capability.

Key Features of the EMAP:

- Ball screw design that features dynamic press load capacity 2.5 to 3 times greater than the stated load capacity
- Integrated load cell
- Servo system is sized to reach press load capacity within the continuous current zone of the motor and drive
- Push or pull with equal accuracy
- Any mounting orientation

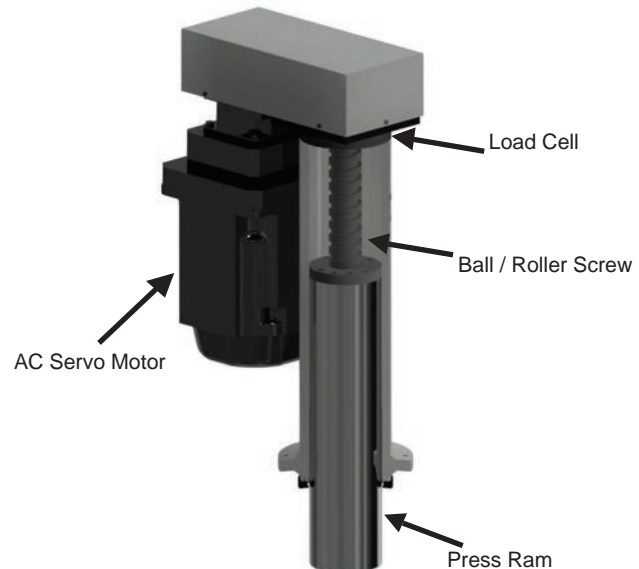

Press Sizes

EMAP Sizes*



| EMAP Sizes | Force | | Travel | | Speed |
|------------|-------|---------|---------------|-------------|---------|
| | kN | LBS | mm | inch | mm/sec |
| EMAP 0.2kN | 0.2 | 45 | 100 | 3.9 | 200 |
| EMAP 01kN | 1 | 225 | 100/300 | 3.9/11.8 | 200/150 |
| EMAP 03kN | 3 | 675 | 100, 300 | 3.9/11.8 | 200 |
| EMAP 05kN | 5 | 1,125 | 200, 350 | 8/13.8 | 200 |
| EMAP 08kN | 8 | 1,800 | 200, 350, 500 | 8/13.8/19 | 200 |
| EMAP 12kN | 12 | 2,700 | 200, 350, 500 | 8/13.8/19 | 200 |
| EMAP 20kN | 20 | 4,500 | 180, 350, 550 | 7/13.8/21.6 | 200 |
| EMAP 30kN | 30 | 6,750 | 180, 350, 550 | 7/13.8/21.6 | 200 |
| EMAP 40kN | 40 | 9,000 | 330, 660 | 13/26 | 200 |
| EMAP 60kN | 60 | 13,500 | 330, 660 | 13/26 | 200 |
| EMAP 80kN | 80 | 18,000 | 330, 660 | 13/26 | 175 |
| EMAP 100kN | 100 | 22,500 | 330, 660 | 13/26 | 200 |
| EMAP 120kN | 120 | 27,000 | 330, 660 | 13/26 | 175 |
| EMAP 160kN | 160 | 36,000 | 400 | 15.75 | 125 |
| EMAP 300kN | 300 | 67,500 | 400 | 15.75 | 100 |
| EMAP 500kN | 500 | 112,000 | 400 | 15.75 | 70 |

* Other sizes, stroke lengths and speeds available

Sample Applications



Press to Position

- Press to a programmable position
- Press to external sensor
- Press to torque
- Press to offset



Press to Shoulder

- Press to a programmable force
- Press to rate of change
- Gauge and press to shoulder
- Gauge force and position



Press to External Transducer

- Press to dimension (external probe)
- Press to flow
- Press to external force
- Press to torque



Crimping/Staking

- Crimp to a programmable force
- Crimp to a relative distance from a touch point
- Stake to a dimension
- Single or multiple staking points



Riveting

- Upset rivet to a force
- Upset rivet to a position
- Upset rivet to a relative dimension on the part
- Upset rivet to a functional specification



Spring Testing

- Measure spring rate
- Measure spring height at defined force
- Measure spring free height
- Measure spring retention



Forming

- Press and hold a constant force
- Press to position
- Press to thickness
- Press to shape

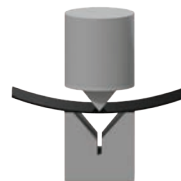

Bending/Straightening

- Bend/straighten to an external measure
- Push and pull to bend/straighten
- Gauge and make

UltraPRO Platform

Promess UltraPRO Technology is a Multi-Axis Motion Control and Sensing platform designed to be used in conjunction with one or more of Promess' Electro-Mechanical units. Its multi-axis, multi sensor capability makes it ideal for your pressing and torquing applications that require more than one axis of motion and/or multiple sensors to perform the operation. Scalable to fit your application.

Flexible System Configuration

Promess software solutions offer a very high level of flexibility allowing our customers to configure the system solution to fit their process requirements.

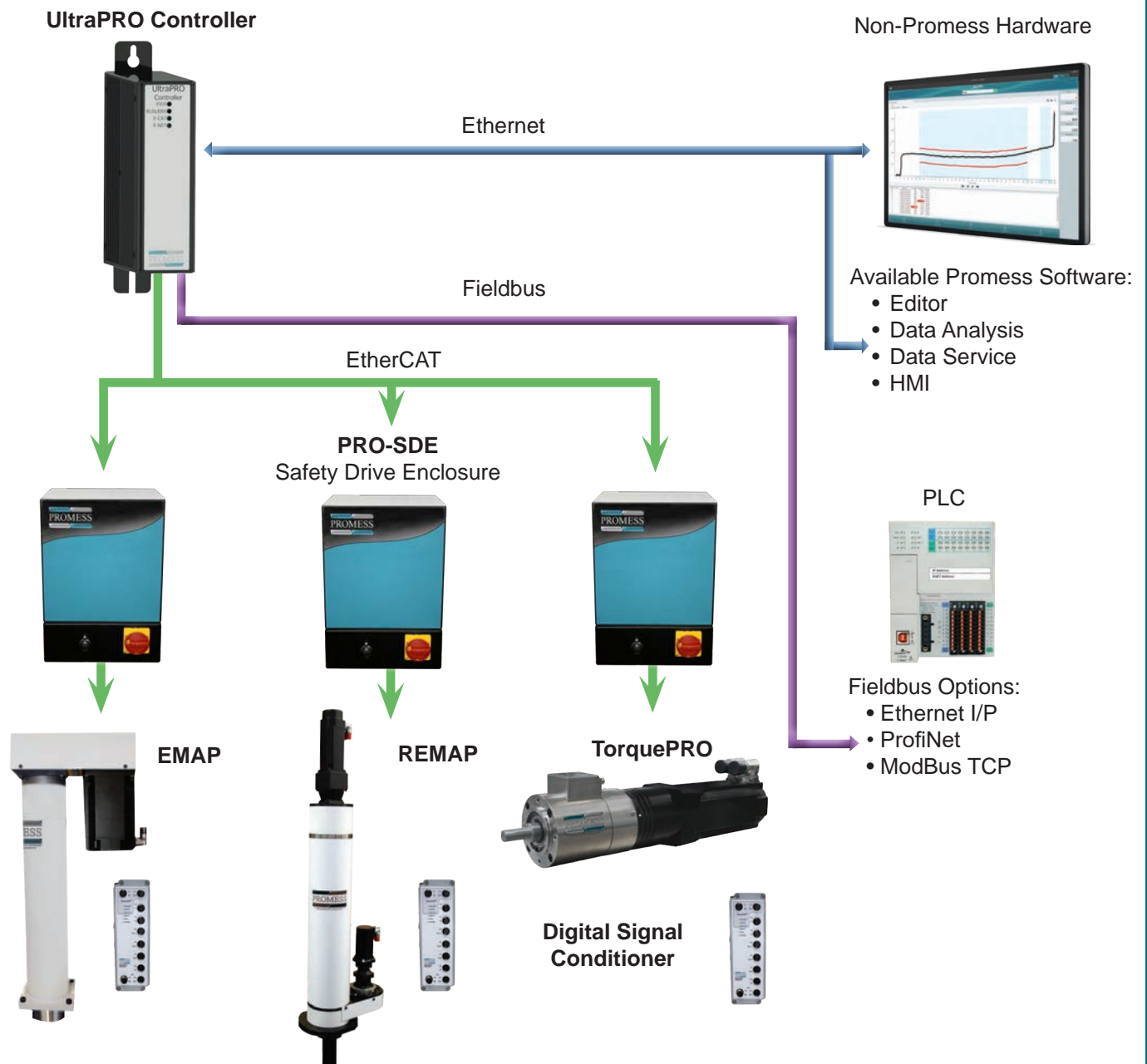

UltraPRO Editor/HMI

Easy menu-driven software includes:

- Rapid application development using powerful commands:

- Motion control
 - Move to position / angle
 - Move to force / torque
 - Move to an external signal
 - Move to a rate of change
 - Move to a compensation factor
- Data acquisition and signature monitoring
 - Acquire force, position, angle or sensor

versus time or distance

- Fixed high and low limits
- Reference curve limits
- Gauge force, position, angle or sensor input
- Pass / fail outputs
- Data storage
- Custom commands
- Custom formulas
- Program debugging aids
- Hardware diagnostics screen
- Manual jog screen
- Controller event logging
- Visualization of:
 - Signature curves
 - Gauge values
 - Live force, position, angle and sensor readings
 - Part status (OK/NOK)
 - Faults and events

- Complete visualization of one or multiple actuators
- Multiple HMIs may be connected to one UltraPRO simultaneously

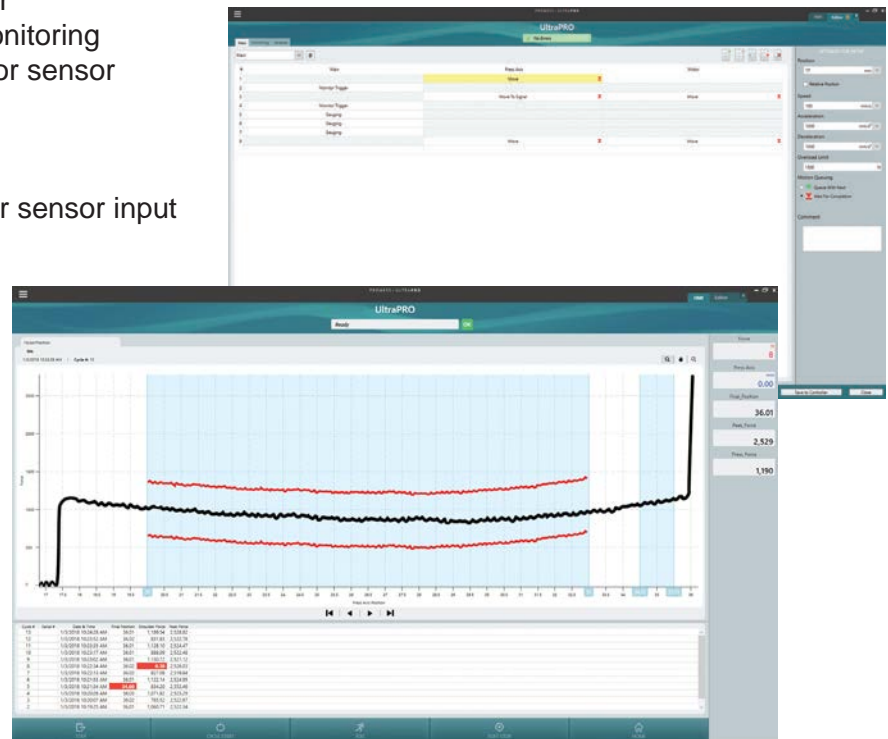

Data Service

Promess Data Service

- Remote data collection
- Easy set up
- Process data storage
 - Signature curve
 - Calculated and gauged values
- Server-level software
- Continuous and reliable storage
- Plug-in architecture:
 - Promess database
 - Q-DAS
 - QualityWorX
 - Custom storage solutions
- Windows 7, Windows 8, Windows Server 2008 compatible
- Serial number tracking

Promess Database Utility

- Provides total data recall of signatures and gauged values
- Works with any Promess Database produced from any Promess product
- Remote viewing using:
 - Microsoft file sharing
 - Dropbox
 - Microsoft SkyDrive
 - USB drives
- Data recall features:
 - Recall monitored graphs
- Overlaid graphs
- Data filtering

Process Development Center

Promess would like to invite you to our Process Development Center. The PDC is available to help you develop your processes and confirm the Promess technology that is best suited for your application. Call today to set up a visit.

The Process Development Center gives you access to:

- EMAP (Electro-Mechanical Assembly Press) Work Stations with capabilities ranging from 0.2kN-300kN
- TorquePRO stations ranging from 1Nm-600Nm
- REMAP (Rotational Electro-Mechanical Assembly Presses) which combines rotational and linear motion in one machine

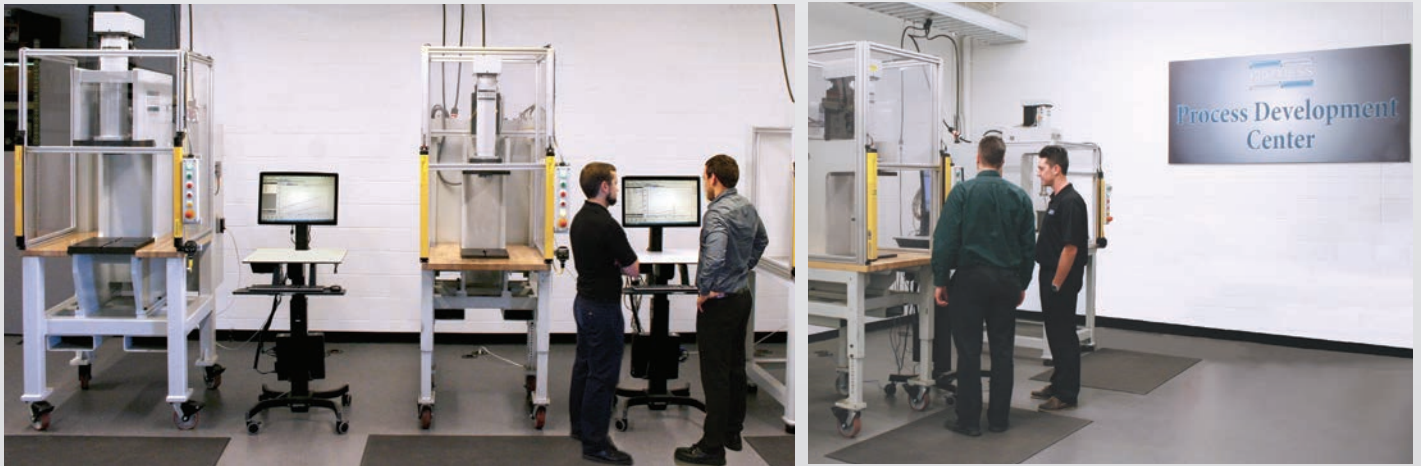

Promess Incorporated



Promess is recognized as a leading U.S. manufacturer of highly adaptive monitoring and motion control systems used by companies around the world to assemble and test their products.



11429 Grand River Road
P.O. Box 748 • Brighton, MI 48116
810-229-9334 • Fax: 810-229-8125
promessinc.com • promess@promessinc.com
Copyright © Promess Incorporated. All rights reserved.



Cloning the perfect part